

Opto Plus LED Corp.
0.51" SMD Type LED Display
OPS-Q5110PG-GW
OPS-Q5111PG-GW

● **FEATURES**

- 0.51 inch (13.0 mm) Digit Height.
- SMD type.
- Low current operation.
- Gray face, White segment.
- RoHS compliant, Pb Free.

● **DESCRIPTION**

The OPS-Q5110LY-GW & OPS-Q5111LY-GW are 0.51 inch (13.0mm) height Quadruple 7-segment displays.

This device utilizes Pure Green LED chip which are made from InGaN on a Transparent GaN, substrate.

The display has Gray face, White segment.

● **DEVICE**

PART NO	DESCRIPTION
OPS-Q5110PG-GW	Common Anode
OPS-Q5111PG-GW	Common Cathode

RoHS Compliance



Pb free.



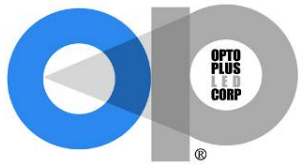

Opto Plus LED Corp.

0.51" SMD Type LED Display

OPS-Q5110PG-GW

OPS-Q5111PG-GW

● MECHANICAL DIMENSIONS

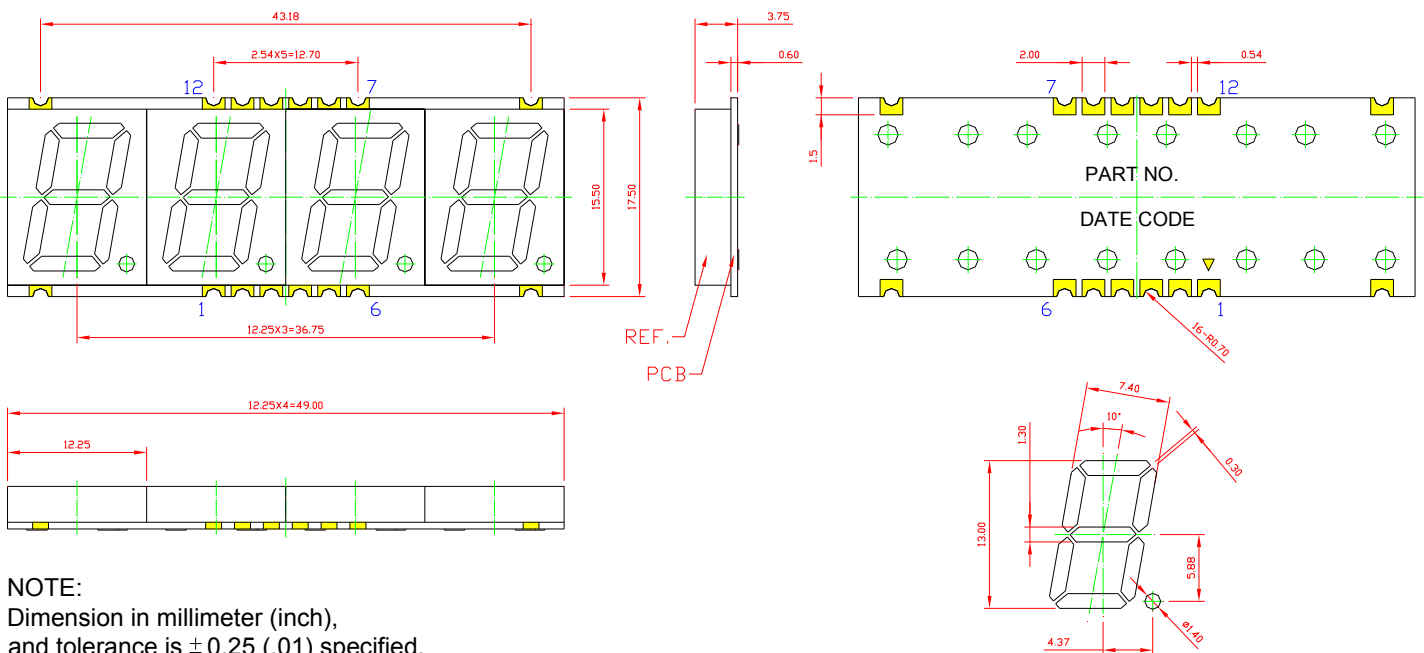

NOTE:
Dimension in millimeter (inch),
and tolerance is ± 0.25 (.01) specified.

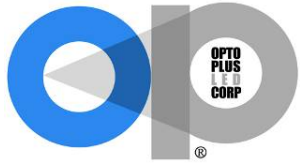

Opto Plus LED Corp.

0.51" SMD Type LED Display

OPS-Q5110PG-GW

OPS-Q5111PG-GW

● TYPICAL INTERNAL EQUIVALENT CIRCUIT

Recommended Soldering Pattern

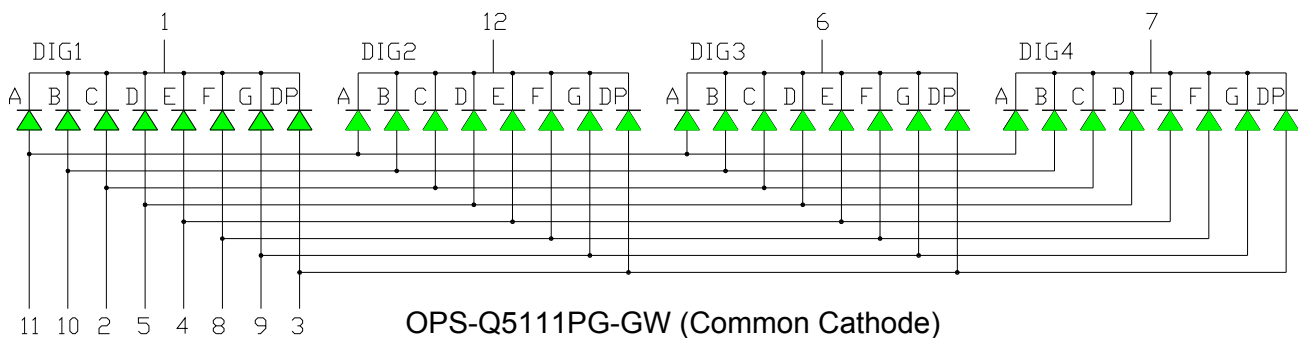
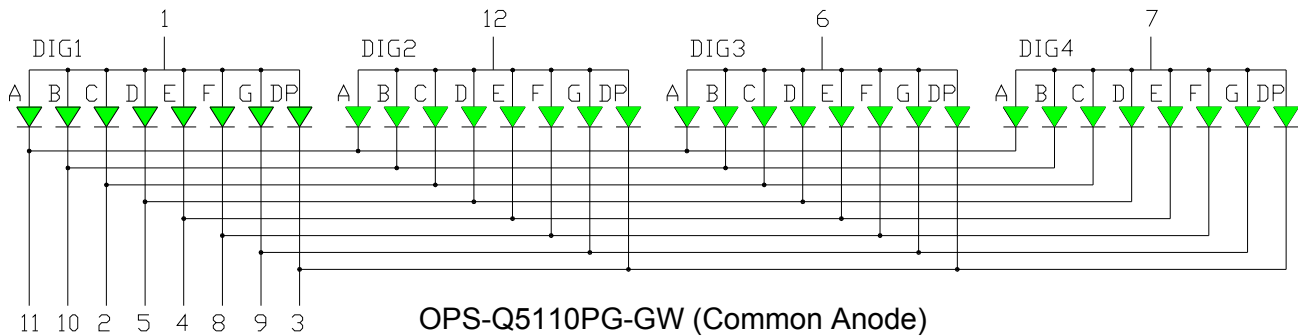
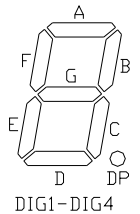
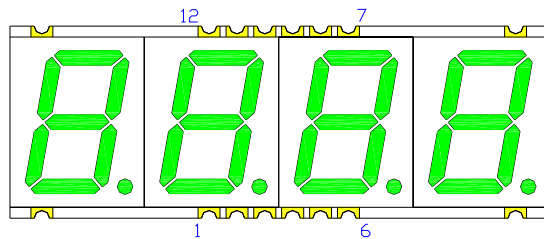
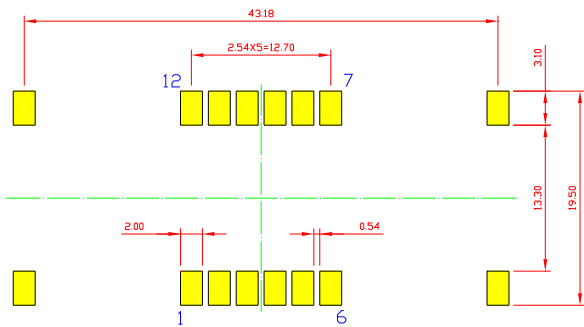

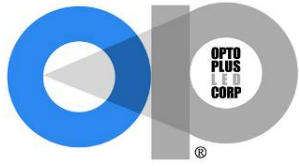

Opto Plus LED Corp.
0.51" SMD Type LED Display
OPS-Q5110PG-GW
OPS-Q5111PG-GW

● **PG: PURE GREEN (InGaN/GaN)**

ABSOLUTE MAXIMUM RATING AT Ta=25°C

Parameter	Symbol	Maximum Rating	Unit
Power dissipation	P _{AD}	120	mW
Derating liner from 25°C	-	0.3	mA / °C
Continuous forward current	I _{AF}	30	mA
Peak current (duty cycle 1/10, 1kHz)	I _{PF}	100	mA
Reverse voltage	V _R	5	V
Operating temperature	T _{OPR}	-40 to +105	°C
Storage temperature	T _{STG}	-40 to +105	°C

ELECTRICAL - OPTICAL CHARACTERISTICS AT Ta=25°C

Characteristic	Symbol	Condition	Min.	Type.	Max.	Unit
Forward Voltage, (Per Dice)	V _F	I _F =20mA	-	3.2	4.0	V
Reverse Current, (Per Dice)	I _R	V _R =8V	-	-	10	μA
Dominant Wavelength	λ _D	I _F =20mA	-	525	-	nm
Luminous Intensity	I _V	I _F =20mA	-	170	-	mcd
Spectral radiation bandwidth	Δλ	I _F =20mA	-	30	-	nm

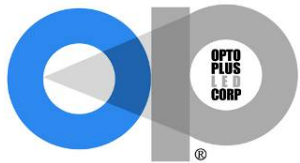

Opto Plus LED Corp.

0.51" SMD Type LED Display

OPS-Q5110PG-GW

OPS-Q5111PG-GW

● PG: PURE GREEN (InGaN/GaN) CURVE

Typical Electro-optical Characteristic Curves (25 °C Free Air Temperature Unless Otherwise Specified)

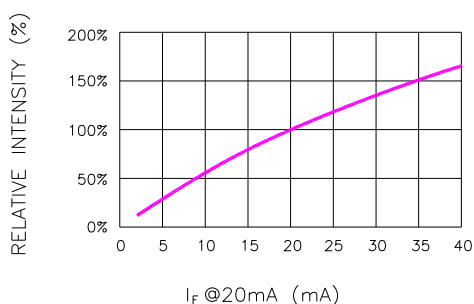

Fig.1 RELATIVE INTENSITY VS. FORWARD CURRENT

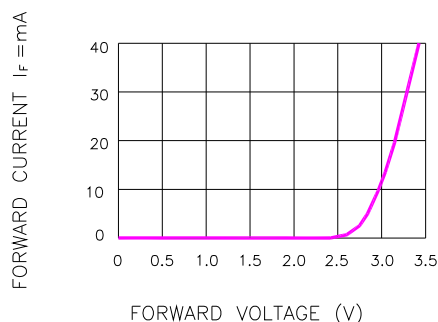

Fig.2 FORWARD CURRENT VS. FORWARD VOLTAGE

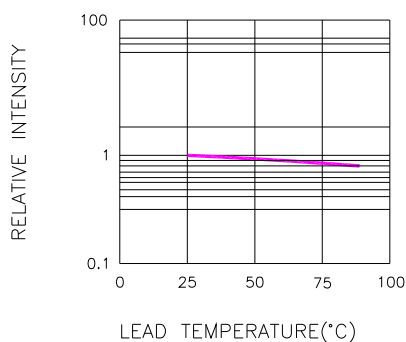

Fig.3 RELATIVE INTENSITY VS. LEAD TEMPERATURE
(PULSED 20 mA; 300us PULSE, 10ms PERIOD)

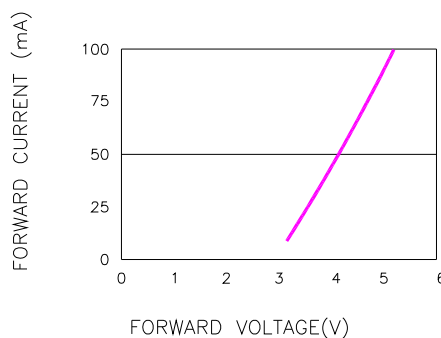

Fig.4 PEAK FORWARD VOLTAGE VS. FORWARD CURRENT
(100us TEST PULSE, 1% DUTY CYCLE)

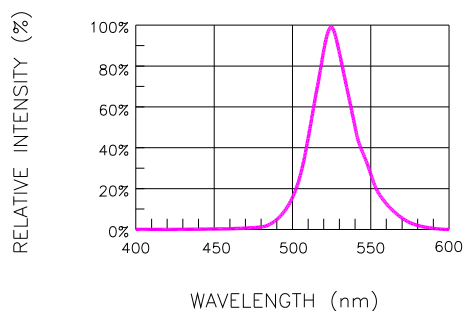

Fig.5 RELATIVE INTENSITY VS. WAVELENGTH

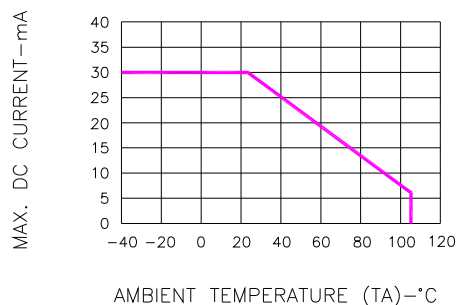
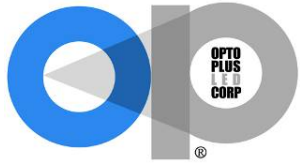

Fig.6 MAX. ALLOWABLE DC CURRENT VS. AMBIENT TEMPERATURE



Opto Plus LED Corp.
0.51" SMD Type LED Display
OPS-Q5110PG-GW
OPS-Q5111PG-GW

● **RECOMMEND SOLDERING PROFILE**

SMT Soldering Profile

Pb free reflow soldering Profile

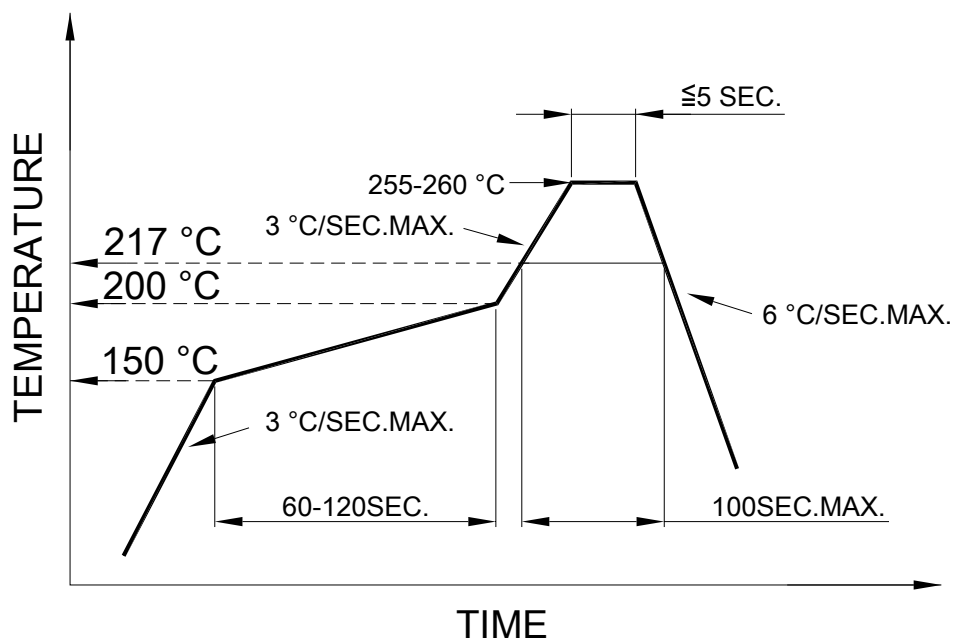

● **SOLDERING IRON**

Basic specification : ≤ 4 seconds when 260°C, If temperature is higher, time should be shorter (+10°C→1 sec). Power dissipation of iron should be smaller than 15W, and temperature should be controllable. Surface temperature of the device should be under 230°C.

● **REWORK**

Customer must finish rework within ≤ 3 sec under 350°C.