

[www.opled.com.tw](http://www.opled.com.tw)

# Opto Plus LED Corp.

## 0.2" SMD Type LED Display

### OPS-S2010LR-GW

### OPS-S2011LR-GW

#### ● FEATURES

- 0.20 inch (5.08 mm) Digit Height.
- SMD type.
- Low current operation.
- Gray face, White segment.
- RoHS compliant, Pb Free.

#### ● DESCRIPTION

The OPS-S2010LR-GW & OPS-S2011LR-GW are 0.20 inch (5.08 mm) height Single digit 7-segment displays.

This device utilizes Deep Red LED chip which are made from AlGaInP on a Transparent GaAs, substrate.

The display has Gray face, White segment.

#### ● DEVICE

PART NO	DESCRIPTION
OPS-S2010LR-GW	Common Anode
OPS-S2011LR-GW	Common Cathode

**RoHS Compliance**



**Pb free.**



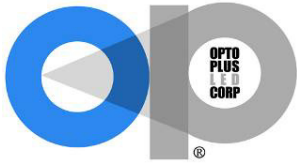

[www.opled.com.tw](http://www.opled.com.tw)

# Opto Plus LED Corp.

## 0.2" SMD Type LED Display

### OPS-S2010LR-GW

### OPS-S2011LR-GW

#### ● MECHANICAL DIMENSIONS

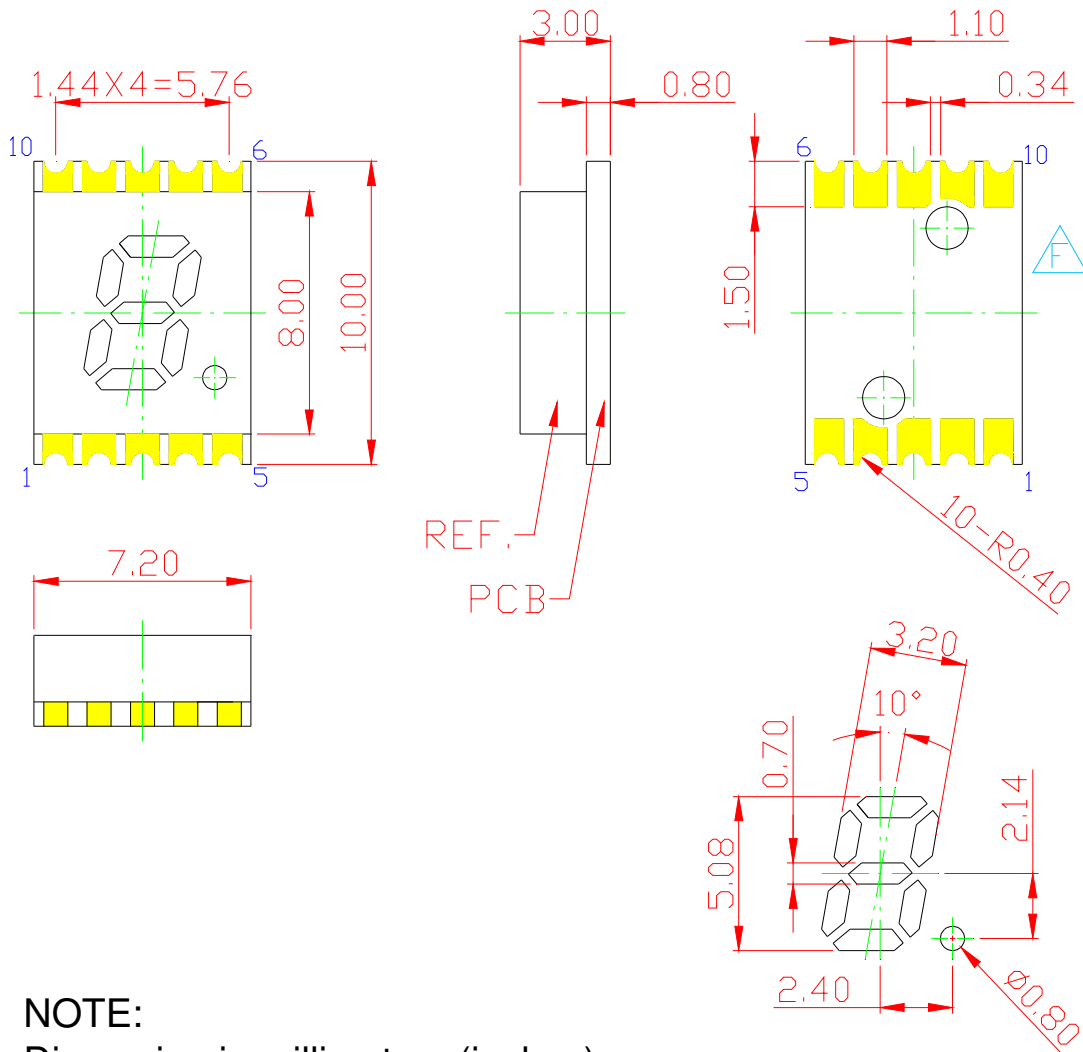

#### NOTE:

Dimension in millimeters (inches),  
and tolerances are  $\pm 0.25\text{mm}$  (.01") specified.

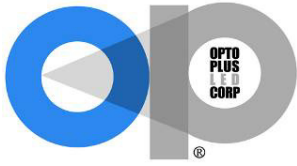

[www.opled.com.tw](http://www.opled.com.tw)

# Opto Plus LED Corp.

## 0.2" SMD Type LED Display

### OPS-S2010LR-GW

### OPS-S2011LR-GW

#### ● TYPICAL INTERNAL EQUIVALENT CIRCUIT

#### Recommended Soldering Pattern

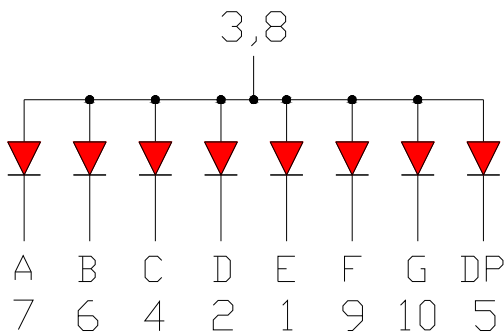
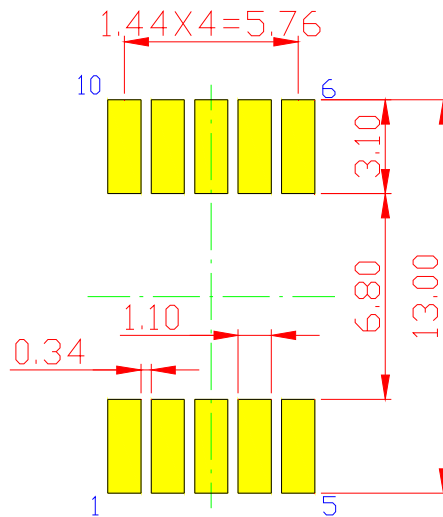
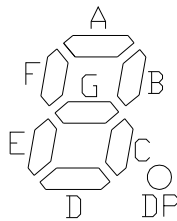
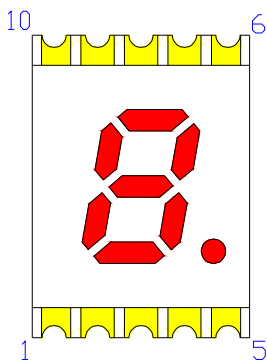

**OPS-S2010LR-GW**  
( Common Anode )

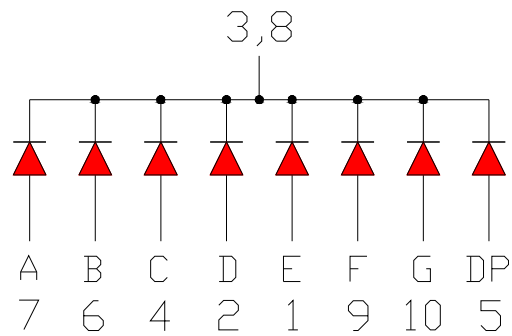

**OPS-S2011LR-GW**  
( Common Cathode )

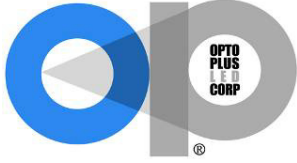

[www.opled.com.tw](http://www.opled.com.tw)

**Opto Plus LED Corp.**  
**0.2" SMD Type LED Display**  
**OPS-S2010LR-GW**  
**OPS-S2011LR-GW**

● **LR: DEEP RED (AlGaInP/GaAs)**

ABSOLUTE MAXIMUM RATING AT Ta=25°C

Parameter	Symbol	Maximum Rating	Unit
Power dissipation	P <sub>AD</sub>	75	mW
Derating liner from 25°C	-	0.3	mA / °C
Continuous forward current	I <sub>AF</sub>	30	mA
Peak current (duty cycle 1/10, 1kHz)	I <sub>PF</sub>	100	mA
Reverse voltage	V <sub>R</sub>	5	V
Operating temperature	T <sub>OPR</sub>	-40 to +105	°C
Storage temperature	T <sub>STG</sub>	-40 to +105	°C

ELECTRICAL - OPTICAL CHARACTERISTICS AT Ta=25°C

Characteristic	Symbol	Condition	Min.	Type.	Max.	Unit
Forward Voltage, (Per Dice)	V <sub>F</sub>	I <sub>F</sub> =20mA	-	2.0	2.5	V
Reverse Current, (Per Dice)	I <sub>R</sub>	V <sub>R</sub> =5V	-	-	10	μA
Peak Wavelength	λ <sub>P</sub>	I <sub>F</sub> =20mA	-	650	-	nm
Dominant Wavelength	λ <sub>D</sub>	I <sub>F</sub> =20mA	635	-	645	nm
Luminous Intensity	I <sub>v</sub>	I <sub>F</sub> =20mA	2	-	15	mcd
Spectral Line Half-Bandwidth	Δλ	I <sub>F</sub> =20mA	-	20	-	nm



# Opto Plus LED Corp.

## 0.2" SMD Type LED Display

### OPS-S2010LR-GW

### OPS-S2011LR-GW

#### ● LR: DEEP RED (AlGaInP/GaAs) CURVE

Typical Electro-optical Characteristic Curves  
(25 °C Free Air Temperature Unless Otherwise Specified)

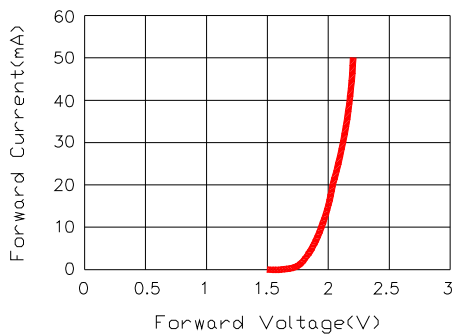

Fig.1 FORWARD CURRENT VS. FORWARD VOLTAGE

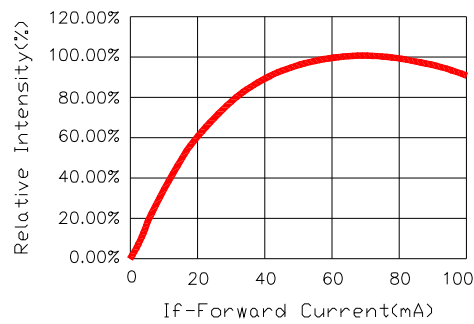

Fig.2 RELATIVE INTENSITY VS. FORWARD CURRENT

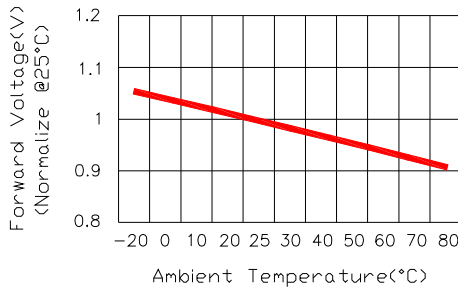

Fig.3 FORWARD VOLTAGE VS. TEMPERATURE

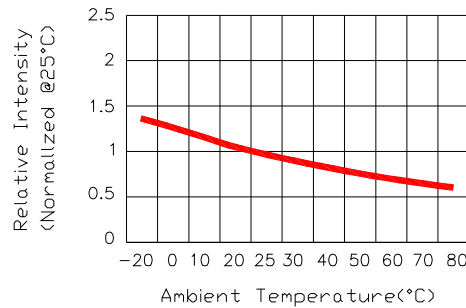

Fig.4 RELATIVE INTENSITY VS. TEMPERATURE

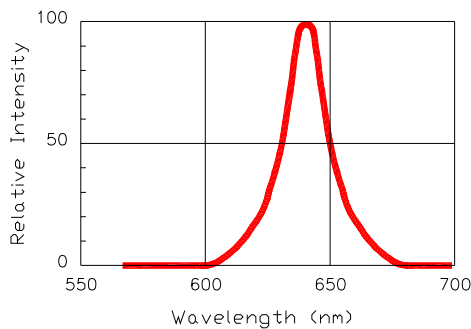

Fig.5 RELATIVE INTENSITY VS. WAVELENGTH

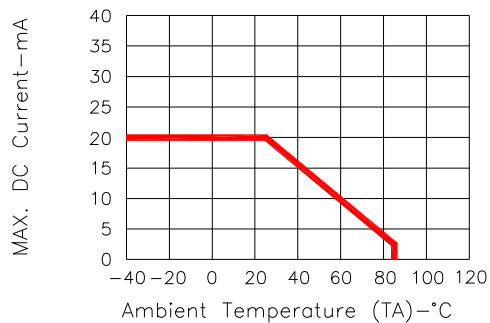
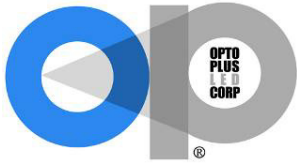

Fig.6 MAX. ALLOWABLE DC CURRENT VS. AMBIENT TEMPERATURE



[www.opled.com.tw](http://www.opled.com.tw)

# Opto Plus LED Corp.

## 0.2" SMD Type LED Display

### OPS-S2010LR-GW

### OPS-S2011LR-GW

## ● SMT REFLOW SOLDERING INSTRUCTIONS

SMT Soldering Profile

Pb free reflow soldering Profile

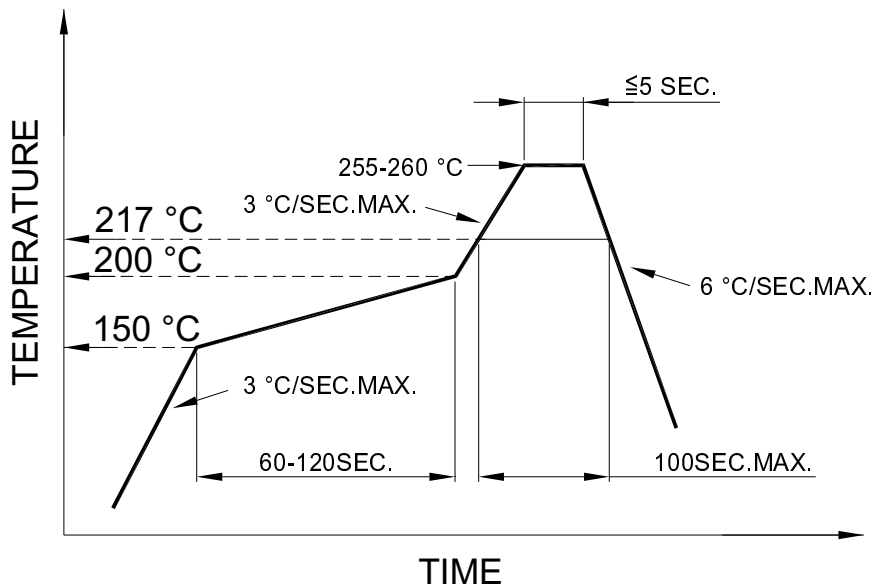

- We recommend the reflow temperature 245°C (+/- 5°C).  
The maximum soldering temperature should be limited to 260°C.
- Number of reflow process shall be 2 times or less.

## ● SOLDERING IRON

Basic spec is  $\leq 4$  sec when 260°C. If temperature is higher, time should be shorter (+10°C → 1 sec). Power dissipation of Iron should be smaller Than 15W, and temperature should be controllable. Surface temperature Of the device should be under 230°C.

## ● REWORK

- Customer must finish rework within 3 sec. under 350°C.
- The head of soldering iron cannot touch copper foil.

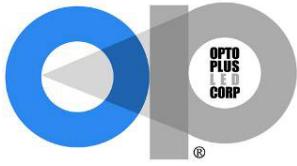

[www.opled.com.tw](http://www.opled.com.tw)

# Opto Plus LED Corp.

## 0.2" SMD Type LED Display

### OPS-S2010LR-GW

### OPS-S2011LR-GW

#### ● REEL DIMENSIONS

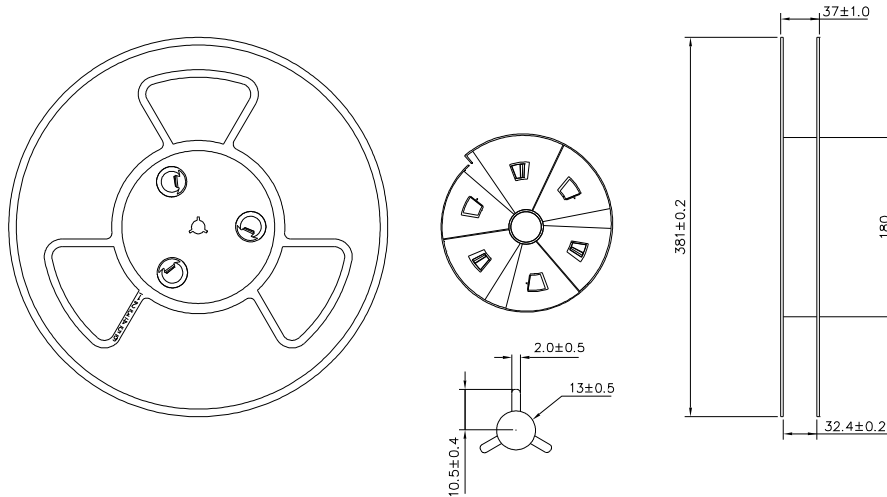

#### ● PACKING & LABEL SPECIFICATIONS

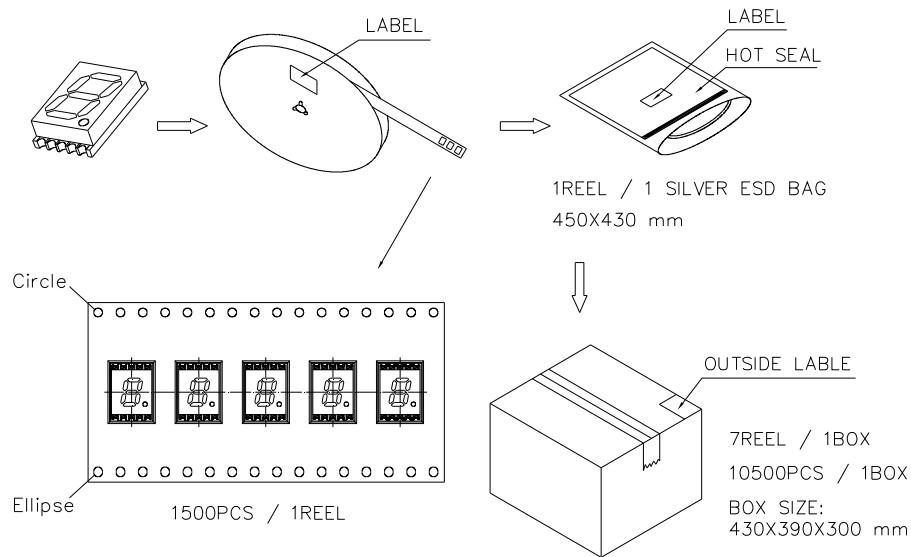

#### ● STORAGE CONDITION

In factory original sealed bag package

TEMPERATURE CONDITION	HUMIDITY CONDITION
5°C ~ 30°C	Below 60%RH

After opened and not in factory original sealed bag package

TEMPERATURE CONDITION	HUMIDITY CONDITION	STORAGE TIME
5°C ~ 30°C	Below 60%RH	Within 4 weeks (MSL as level 2a)